

Changes for the Better

 **MITSUBISHI
ELECTRIC**
AIR CONDITIONERS

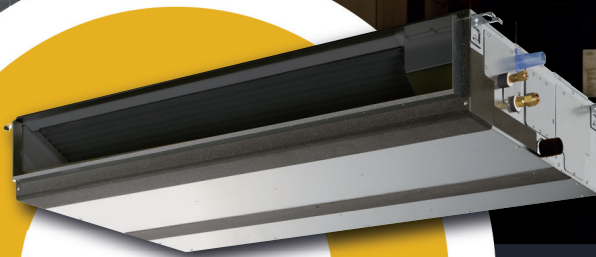

Mr. SLIM
Non-inverter

The MEQ Difference

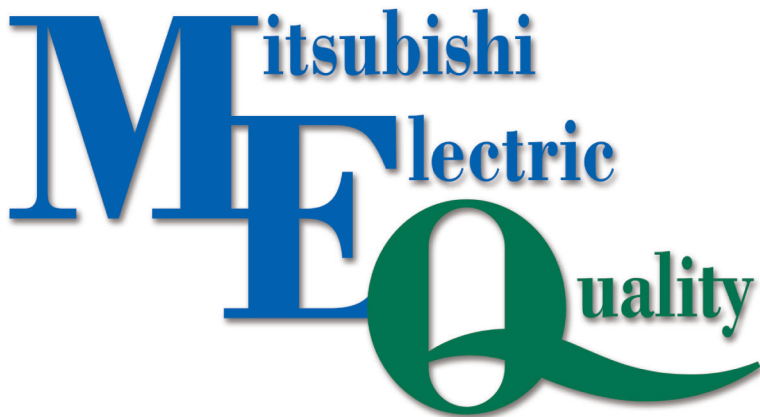

Simply meeting industry standards, however stringent, is not enough. Our aim is to exceed them. When it comes to comfort, efficiency and durability, Mitsubishi Electric offers you a distinctive advantage. We call it MEQ — Mitsubishi Electric Quality. It results in benchmark leading-edge products like our air conditioners, which consume minimal power, protect your investment through a long service life, offer superior reliability and are built to take the punishment of extreme weather conditions year in and year out.

Mitsubishi Electric Offers Three Important Advantages

Comfort

Clean air, optimum temperature distribution and silent operation...

MEQ has led to the development of state-of-the-art air purification and deodorization filters that remove unwanted odors and impurities in the air. Original airflow technologies and specially designed components provide even temperature distribution — even in remote regions of a room. At Mitsubishi Electric, comfort doesn't simply mean cool or warm, it means clean and quiet too.

Efficiency

Optimum cost performance and energy savings...

MEQ results in air conditioners that are rated among the best in the industry in terms of quality and energy efficiency. We strive for a perfect balance of performance, reliability, low power consumption and long service life. This is complemented by continuously introducing new technologies and components that further reduce energy requirements and negative environmental impact.

Durability

Rugged construction, rigorous testing, long-lasting operation...

MEQ is behind a mindset that goes to extremes to ensure higher quality products that protect the initial investment over years of reliable service. We subject our indoor and outdoor units to rigorous durability testing, including harsher temperature extremes than likely found anywhere in the world.



















Ceiling-Cassette
(PL-M SERIES)



Ceiling-Concealed
(PE-M SERIES)

Outdoor Unit

| | | | |
|-------------------|--|---|--|
| 2HP |  PL-M18BAK |  PE-M18JAK |  PU-M18VAK |
| 2.5HP |  PL-M24BAK |  PE-M24JAK |  PU-M24VAK/PU-M30VAK |
| 3HP |  PL-M30BAK |  PE-M30JAK |  PU-M24VAK/PU-M30VAK |
| 4HP |  PL-M36BAK |  PE-M36JAK |  PU-M36YAK/PU-M48YAK |
| 6HP |  PL-M48BAK |  PE-M48JAK |  PU-M36YAK/PU-M48YAK |
| Remote Controller |  |  * | |

*Corded Remote (Standard) Available with Ceiling Concealed

Doing Our Part to Create a Better Future for All...

Core Environmental Policy

The Mitsubishi Electric Group promotes sustainable development and is committed to protecting and restoring the global environment through technology, through all its business activities, and through the actions of its employees.

Environmental Vision 2021

Making Positive Contributions to the Earth and its People through Technology and Action

Preventing Global Warming

- Reduce CO₂ emissions from product usage by 30%
- Reduce total CO₂ emissions from production by 30%
- Aim to reduce CO₂ emissions from power generation

Creating a Recycling-Based Society

- Reduce, reuse and recycle “3Rs” products reduce resources used by 30%
- Zero emissions from manufacturing reducing the direct landfill of waste to zero

Ensuring Harmony with Nature Fostering Environmental Awareness

IMPORTANT FEATURES

High Energy Efficiency

The new R32 SLIM series realize high energy savings with its high energy efficiency. All models in the series have improved energy efficiency, and are contributing to reduced energy consumption in homes, offices and a range of other settings. Offered in a variety of output capacities and installation patterns, the vast applicability promises and ideal match for any user.

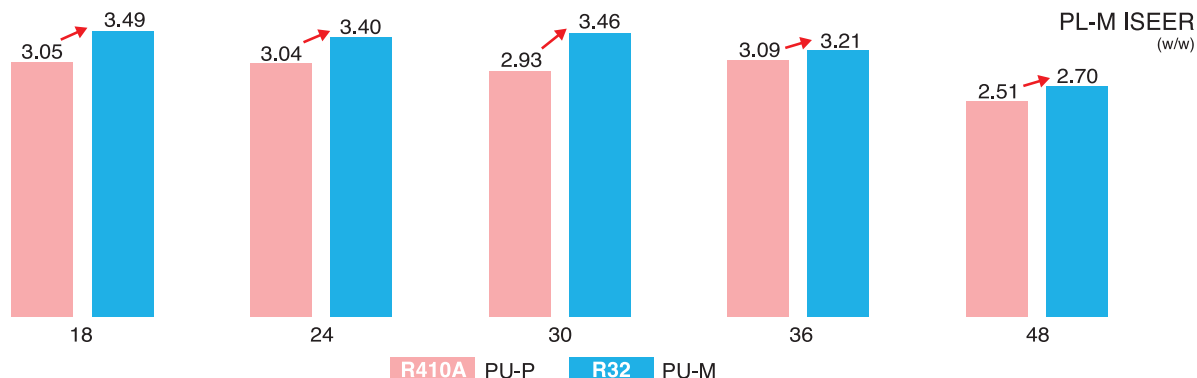

Specifications reported are figures when PL-P**BAK/PL-M**BAK is connected.

Improved Cooling Capacity*

With the improved cooling capacity, this new line-up provides optimum performance and room comfort wherever they are installed.

| Capacity Class | Rated Cooling Capacity (BTU/h) | | |
|----------------|--------------------------------|----------|-----------------|
| | R410A PL-P | R32 PL-M | Improvement (%) |
| 18 | 17,400 | 18,600 | 6% |
| 24 | 22,500 | 23,200 | 3% |
| 30 | 28,300 | 30,000 | 6% |
| 36 | 35,500 | 36,100 | 1% |
| 48 | 45,000 | 48,100 | 6% |

* As compared to previous models PL-P series

Longer piping (18/24/30/36)*

Longer piping length(18/24/30/36) and longer height difference(18/24/30) are realized. Widely increasing installation flexibility.

| Capacity Class | Max. Piping Length (m) | | Max. Height Difference (m) | |
|----------------|------------------------|----------|----------------------------|----------|
| | R410A PU-P | R32 PU-M | R410A PU-P | R32 PU-M |
| 18/24 | 30 | 35 | 10 | 20 |
| 30 | 30 | 50 | 15 | 30 |
| 36 | 40 | 50 | 30 | 30 |
| 48 | 50 | 50 | 30 | 30 |

* As compared to previous model PU-P

Light weight and compact size (36/48)*

Compact outdoor unit design fits well into narrow space and provides optimal solution for condominiums and showrooms.

PU-M36/48YAK

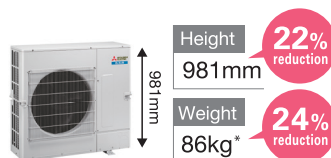

Easy transportation and installation*

The compact size of outdoor unit allow for better transportation performance. Carrying and installing become easier.

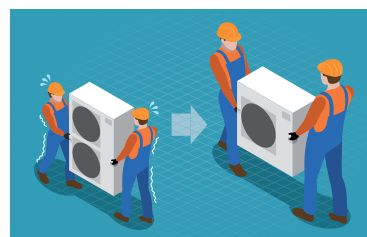

Transport efficiency improves thanks to its low height. The unit can even be transported by minivan.

* As compared to previous models PU-P

NEW Blue fin condenser

A special coating is applied to the heat exchanger to increase corrosion resistance capabilities.







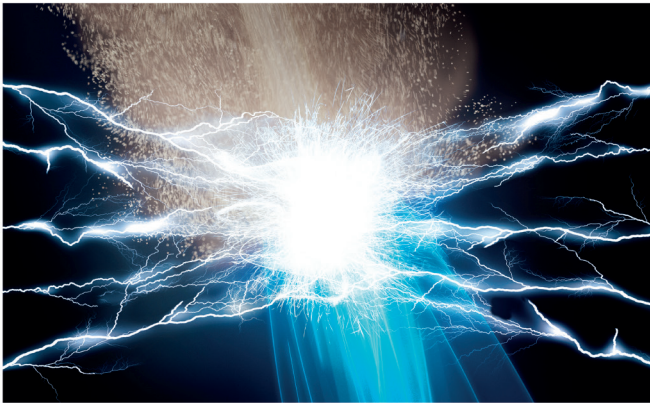

AIR PURIFYING TECHNOLOGY

▶ Plasma Quad Connect*

Plasma Quad Connect is an high-performance air purifying device which can even be installed on the existing units, contributing to a better air quality in your room. Plasma Quad Connect applies a voltage of 6,000 volts to the electrode to generate plasma, effectively removing various kinds of particles such as viruses, bacteria, moulds, allergens, dust and PM2.5.



| | | | |
|---|---|---|---|
|  | Virus 99% inhibited* ¹ * ² |  | Bacteria 99% inhibited* ² |
|  | Mold 99% inhibited* ² |  | Dust 99.7% inhibited |
|  | Allergen 98% inhibited |  | PM 2.5 99% inhibited* ² |

*1 The result of test with Influenza A virus. *2 The result is based on the test with a device installed on the representative indoor unit. (MSZ-AP series)

Filter and allergens particle sizes

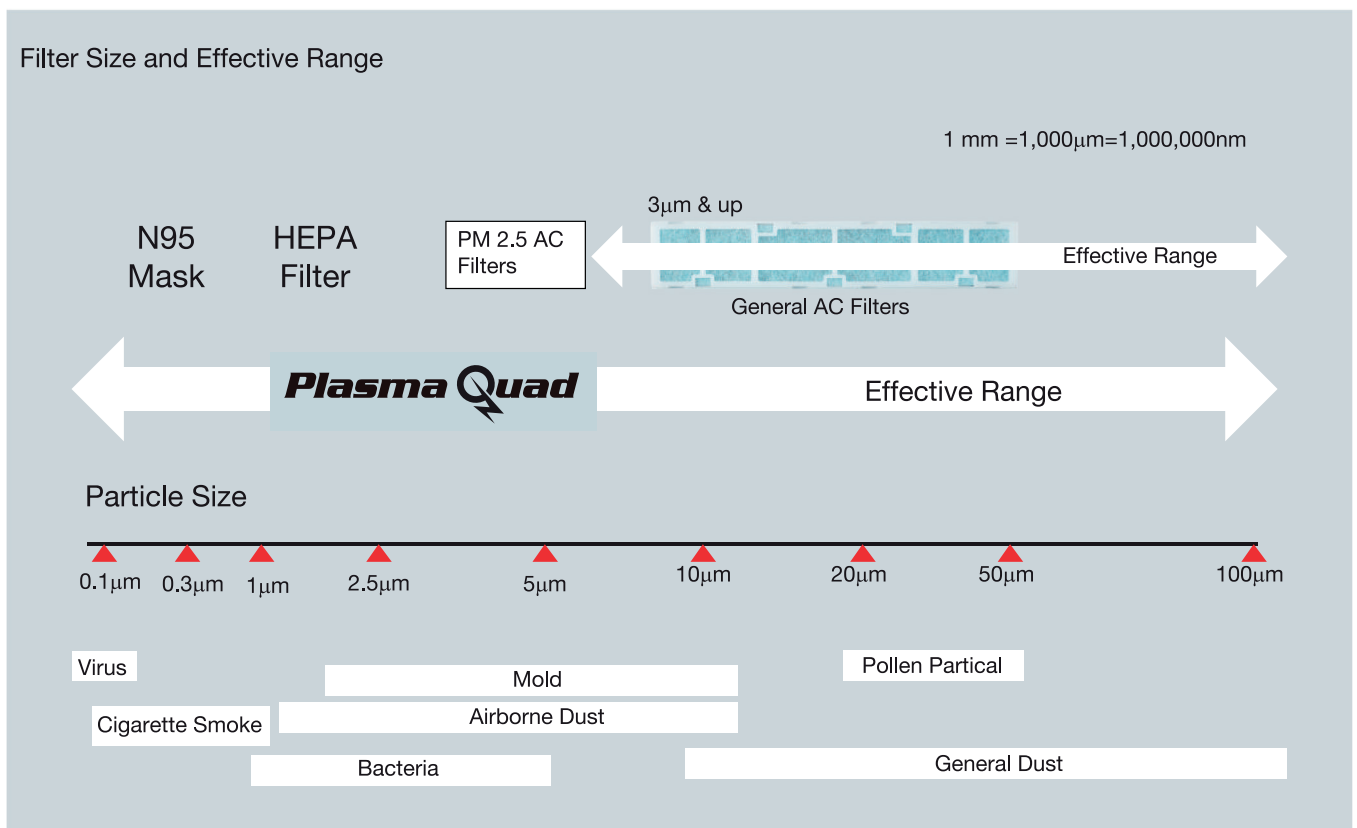

*Optional feature

FUNCTIONS & TECHNOLOGIES

| Category | Combination | Indoor unit | PL-M18/24/30/36/48BAK | | PE-M18/24/30/36/48JAK | | |
|------------------|---|----------------------------|-----------------------|--------------|-----------------------|--------------|-----|
| | | Outdoor unit | PU-M18/24/30VAK | PU-M36/48YAK | PU-M18/24/30VAK | PU-M36/48YAK | |
| Technology | Grooved Piping | | ● | ● | ● | ● | |
| Functions | Air Quality | Long-life Filter | ● | ● | | | |
| | | Filter Check Signal | ● | ● | ● | ● | |
| | Air Distribution | Auto Vane | ● | ● | | | |
| | | Horizontal Vane | ● | ● | | | |
| | | High Ceiling Mode | ● | ● | | | |
| | | Low Ceiling Mode | ● | ● | | | |
| | | Auto Fan Speed Mode | ● | ● | | | |
| | Convenience | On/Off Operation Timer | ● | ● | ● | ● | |
| | | Auto Restart | ● | ● | ● | ● | |
| | System Control | Centralised On/Off Control | | Opt | Opt | Opt | Opt |
| | | System Group Control | | Opt | Opt | Opt | Opt |
| | | M-NET Connection | | Opt | Opt | Opt | Opt |
| | Installation | Cleaning-free Pipe Reuse | | ●* | ● | ●* | ● |
| | | Drain Pump | | ● | ● | Opt | Opt |
| Flare Connection | | | ● | ● | ● | ● | |
| Maintenance | Self-Diagnostic Function (Check Code Display) | | ● | ● | ● | ● | |
| | Failure Recall Function | | ● | ● | ● | ● | |

* Opt: Separate parts must be purchased.

*Not available for different diameter joints.



Horizontal Vane

The air outlet vane swings up and down so that the airflow is spread evenly throughout the room.



Vertical Vane

The air outlet fin swings from side to side so that the airflow reaches every part of the room.



On/Off Operation Timer

Use the remote controller to set the times of turning the air-conditioner On/Off.



Auto Restart

Especially useful at the time of power outages, the unit turns back on automatically when power is restored.



Long-life Filter

A special process for the entrapment surface improves the filtering effect, making the maintenance cycle longer than that of units equipped with conventional filters.



Filter Check Signal

Air conditioner operating time is monitored, and the user is notified when filter maintenance is necessary.



High Ceiling Mode

In the case of rooms with high ceilings, the outlet-air volume can be increased to ensure that air is circulated all the way to the floor.



Low Ceiling Mode

If the room has a low ceiling, the airflow volume can be reduced for less draft.



Auto Fan Speed Mode

The airflow speed mode adjusts the fan speed of the indoor unit automatically according to the present room conditions.



Drain Pump

A built-in drain pump enables drain piping to be raised.

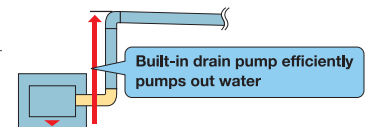

Self-Diagnostic Function (Check Code Display)

Check codes are displayed on the remote controller or the operation indicator to inform the user of malfunctions detected.



Failure Recall Function

Operation failures are recorded, allowing confirmation when needed.

4-way Ceiling-Cassette

(PL-M SERIES)



PL-M18/24/30/36/48BAK



This compact, multifunctional indoor unit has sophisticated design that goes well with any interior & provides high level of convenience while enhancing your quality of life.

Wide Airflow

Wide-angle outlets distribute airflow to all corners of the room, ensuring the room is sufficiently cooled/heated. Horizontal airflow and a fan speed reduced by 20% compared to conventional models also contribute to increased comfort for occupants.

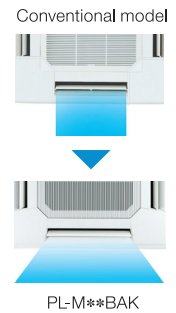

Less Cold Draft

The horizontal airflow function prevents cold drafts from striking the body directly, thereby keeping the body from becoming chilled.

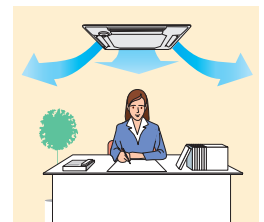

Horizontal airflow prevents drafty feeling

Wide-flow Air Outlet

The high-power ceiling cassettes offer a wide-flow air outlet that enables effective air conditioning of rooms with atrium ceilings up to 4.5m in height. The demands of high-ceiling applications such as halls, showrooms or shopping malls can now be fully answered thanks to this powerful, yet highly efficient airflow.

Ideal for high-ceiling applications as high as **4.5m** (PL-M30/36/42/48BAK)

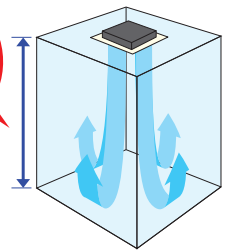

■ Specification according to ceiling height

(Unit: m)

| | PL-M18/24BAK | | | PL-M30/36/48BAK | | |
|-------|--------------|----------|--------------|-----------------|----------|--------------|
| | Low ceiling* | Standard | High ceiling | Low ceiling* | Standard | High ceiling |
| 4-way | 2.5 | 2.7 | 3.5 | 2.7 | 3.2 | 4.5 |

* If required to use Low Ceiling mode under high humidity conditions, please consult with your Mitsubishi Electric dealership since there is some risk of condensation.

Automatic Air-speed Adjustment

An automatic air-speed adjustment mode is provided in addition to the four air-speed stages, of High, Medium 1, Medium 2, and Low. Air speed can be changed freely according to the difference between set temperature and room temperature. The automatic air-speed adjustment mode offers quick cooling of a room in High mode, such as when starting cooling operation. After the room temperature is stabilized, the system switches to Low mode automatically to maintain comfort.



(When using the wireless remote controller, an extra setting is required.)

Automatic Vane Shutter*

When the air conditioner is not operating, the vane shutter closes automatically to conceal the air outlet and create an aesthetically appealing flat surface.

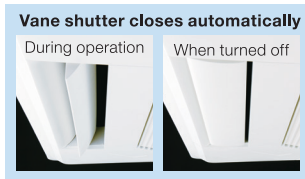

Unit Height of Only 258mm (PL-M18/24BAK)

Ceiling cassette models boast a slim body height for smooth and aesthetic installation, even in narrow spaces.



"Pure White" Colour Matches Interior Décor

The colour "Pure White" has been introduced for the decoration panel and wired remote controller so as to blend in with any interior décor.

Quiet Operation

An improved airflow path and powerful high-capacity flow fan contribute to the realisation of quieter operation.



Other Features

- Maximum upward draining of 850mm
- Wireless remote controller available
- Branch duct

Vane Control

For Shopping Malls **Wide airflow coverage down to the floor even in expansive spaces like large factory-outlet centers or shopping malls with high ceilings.**

The unique airflow design of the powerful ceiling-cassette models reduces pressure loss and provides wide cool-air coverage from high ceilings to the floor even in expansive spaces like shopping malls with ceilings over 4m in height.

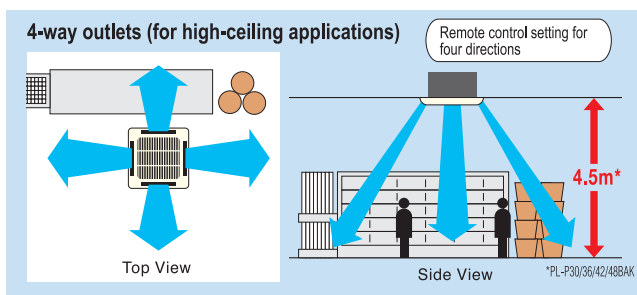

i-see Sensor

(optional corner panel)

The "i-see Sensor" built into the optional corner panel eliminates uneven temperature distribution and reduces electricity consumption.

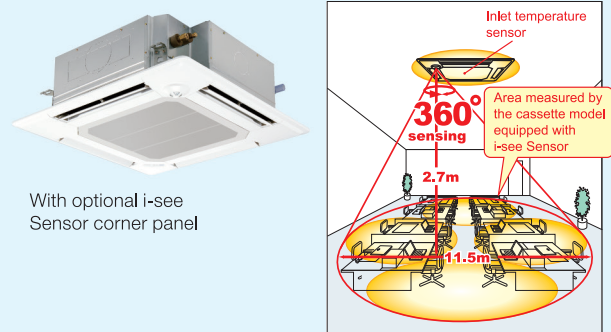

With optional i-see Sensor corner panel

"i-see Sensor" temperature-sensing technology improves energy efficiency and enhances room comfort

The "i-see Sensor" is an innovative Mitsubishi Electric technology that uses a radiation-based sensor to monitor temperature throughout an entire room. When connected to the air conditioner control panel, the "i-see Sensor" works to maximize room comfort.

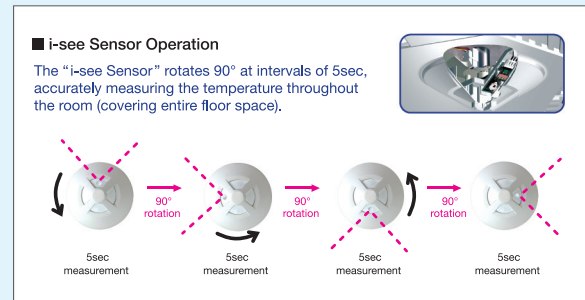

Sensible temperature control prevents excessive cooling through pioneering control technology

By measuring the inlet temperature and floor temperature, temperatures felt by the human body (sensible temperature) are computed. This allows the proper sensible temperature to always be maintained through the suppression of excessive cooling.

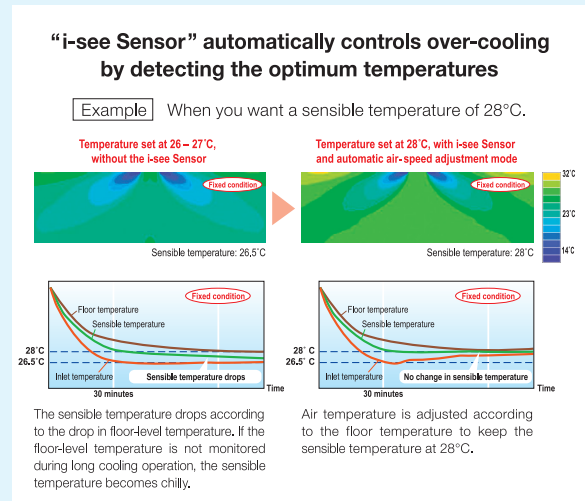

Drain Water Lifting Mechanism

A high-performance drain pump on the drain water lifting mechanism allows the drain water pipe to be routed as high as 850mm from the ceiling surface.

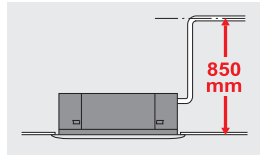

Handy Corner Pocket Design Simplifies Maintenance

By using the handy pockets equipped on the four corners of the grille, maintenance work such as drain pan cleaning and height adjustments can be accomplished without removing the grille.



Bacteria- and Mold-resistant Specifications

Mitsubishi Electric filters are bacteria-resistant, and the drain pans are designed to prevent the growth of mold for fresh and pleasant air conditioning at all times.

Features at a glance

| Installation & Maintenance | Comfort | Others |
|-------------------------------|--------------------------------------|---|
| • Chargeless system | • i-see Sensor | • System control |
| • Compact design | • Auto fan speed | • Auto vane shutter |
| • Drain water lifting (850mm) | • Wide vane | • Auto restart |
| • Handy corner pocket | • Smudge/draft-free | |
| • Long-life filter (2500hr)* | • High-ceiling application | • Outdoor unit max. operating temp. of 46°C |
| • Self-diagnostic function | • Computerized dehumidifier | |
| • Flockless vanes | • Quiet operation | |
| • Elevation grille | • Bacteria-and mold-resistant filter | |

*May vary according to operating conditions.

| Models | | PL-M18BAK-DA | PL-M24BAK-DA | PL-M30BAK-DA | PL-M36BAK-DA | PL-M48BAK-DA | |
|------------------|----------------------------------|-----------------------------|--------------------------|--------------------------|-------------------|---------------------------|-------------------|
| Cooling capacity | kW | 5.45 | 6.80 | 8.80 | 10.60 | 14.10 | |
| Cooling capacity | BTU/h | 18,600 | 23,200 | 30,000 | 36,100 | 48,100 | |
| Total input | kW | 1.56 | 2.00 | 2.54 | 3.30 | 5.22 | |
| EER | W/W | 3.49 | 3.40 | 3.46 | 3.21 | 2.70 | |
| ISEER | W/W | 3.49 | 3.40 | 3.46 | 3.21 | 2.70 | |
| Indoor unit | Model name | PL-M18BAK-DA | PL-M24BAK-DA | PL-M30BAK-DA | PL-M36BAK-DA | PL-M48BAK-DA | |
| | Power supply | 1ph 220-240V 50Hz | | | | | |
| | External finish | Munsell 6.4Y 8.9/0.4 | | | | | |
| | Airflow (low-high) | CMM | 14-16-18-20 | | 19-22-25-28 | 20-24-27-30 | 24-26-29-32 |
| | | CFM | 495-565-635-705 | | 670-775-885-990 | 705-850-955-1060 | 850-920-1025-1130 |
| | External static pressure | Pa | 0 (direct blow) | | | | |
| | Operation control and thermostat | Remote control and Built-in | | | | | |
| | Noise level (low-high) | dB (A) | 28-30-33-35 | | 32-36-39-42 | 33-37-40-43 | 38-40-42-45 |
| | Unit drain pipe | mm | 32 | | | | |
| | Dimensions (panel) | W | 840 (950) | | | | |
| D | | 840 (950) | | | | | |
| H | | 258 (35) | | 298 (35) | | | |
| Weight (panel) | kg | 23(6) | | 25(6) | 27(6) | | |
| Outdoor unit | Model name | PU-M18VAK-DA | PU-M24VAK-DA | PU-M30VAK-DA | PU-M36VAK-DA | PU-M48VAK-DA | |
| | Power supply | 1ph 220-240V 50Hz | | | 3ph 380-415V 50Hz | | |
| | External finish | Munsell 3.0Y 7.8/1.1 | | | | | |
| | Refrigerant (R32) control | Capillary Tube | | | | | |
| | Airflow | CMM (CFM) | 32 (1130) | 59 (2084) | 50 (1765) | 92 (3249) | |
| | Noise level | dB (A) | 53 | 56 | 55 | 54 | 56 |
| | Dimensions | W | 718 | 840 | | 1050 | |
| | | D | 255 | 330 | | 330 | |
| | | H | 525 | 880 | | 981 | |
| | Weight | kg | 35 | 51 | 63 | 82 | 86 |
| | Max. height difference | m | 20 | | 30 | | |
| | Max. piping length | m | 35 | | | 50 | |
| | Pipe size (outer diameter) | mm | Liquid: 6.35 , Gas: 12.7 | Liquid: 6.35 ,Gas: 15.88 | | Liquid: 9.52 , Gas: 15.88 | |
| BEE Star Rating | | | | | | - | |
| Operating Range | Upper limit (CDB) | 46 | | | | | |
| | Lower limit (CDB) | 21 | | | | | |

• Rating conditions Cooling - Indoor: 27°C(80°F)DB, 19°C(66°F)WB, Outdoor: 35°C(95°F)DB
 • Refrigerant piping length (one-way): 7.5m(25ft)
 • Total input based on the indicated voltage (indoor/outdoor): 1ph 230V 50Hz, 3ph 400V 50Hz
 • The sound pressure measurement is conducted in an anechoic chamber under the test conditions of Japanese industrial Standards.
 • The actual sound level depends on the distance from the unit and acoustic environment.

Ceiling-Concealed

(PE-M SERIES)

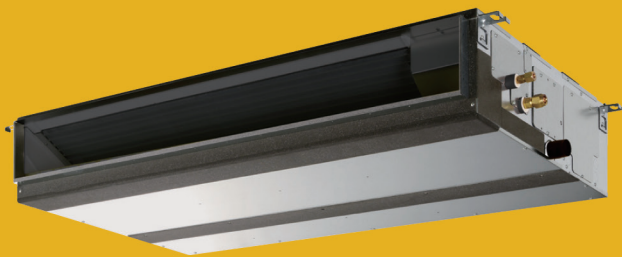

PE-M18/24/30/36/48JAK



The ultra thin, ceiling-concealed indoor units of PE-M series are the perfect answer for air-conditioning requirements of buildings with low ceiling heights having confined installation space and wide-ranging external static pressure.

Compact Indoor Units

For all models, unit height is unified to 250mm. Compared to the previous model, height has been reduced, allowing installation in tight spaces such as ceiling cavities or drop-ceilings.

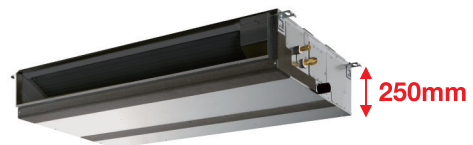

PE-M18/24/30/36/48JAK

Height reduced

Air Inlet

Units with bottom inlets make more noise than those with rear inlets. It is recommended that the rear inlet be selected when installing a unit in a room that should be quiet, such as a bedroom.

(1) Rear inlet

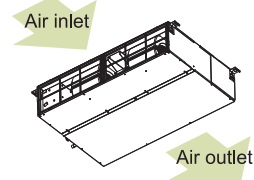

(2) Bottom inlet

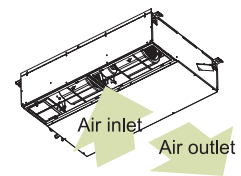

Wide Selection of External Static Pressure

Three-stage external static pressure conversions are available. Capable of being set to a maximum of 70Pa, units are applicable to a wide range of building types.

External static pressure setting

| Series | 18 | 24 | 30 | 36 | 48 |
|----------|---------|----|----|------------|----|
| PE-M-JAK | 30/50Pa | | | 30/50/70Pa | |

Flexible duct design

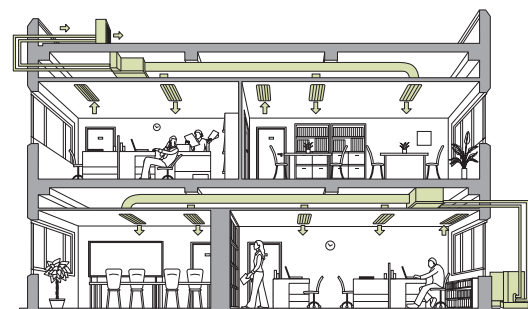

Features at a glance

| Installation & Maintenance | Comfort | Others |
|--|--|---|
| <ul style="list-style-type: none"> • Chargeless system • Smooth installation • Self-diagnostic function | <ul style="list-style-type: none"> • Computerized dehumidifier • Quiet operation • Drain pump(optional) | <ul style="list-style-type: none"> • System control • Auto restart • Outdoor unit max. operating temp. of 46°C |



| Models | | | PE-M18JAK-DA | PE-M24JAK-DA | PE-M30JAK-DA | PE-M36JAK-DA | PE-M48JAK-DA | |
|----------------------------|----------------------------------|-----------|-----------------------------|--------------------------|---------------------------|-------------------|--------------|----|
| Cooling capacity | | kW | 5.45 | 6.60 | 8.80 | 10.40 | 14.10 | |
| Cooling capacity | | BTU/h | 18,600 | 22,500 | 30,000 | 35,500 | 48,100 | |
| Total input | | kW | 1.63 | 2.10 | 2.67 | 3.35 | 5.22 | |
| EER | | W/W | 3.35 | 3.14 | 3.30 | 3.10 | 2.70 | |
| Indoor unit | Model name | | PE-M18JAK-DA | PE-M24JAK-DA | PE-M30JAK-DA | PE-M36JAK-DA | PE-M48JAK-DA | |
| | Power supply | | 1ph 220-240V 50Hz | | | | | |
| | External finish | | Galvanized steel plate | | | | | |
| | Airflow (low-high) | CMM | 17.5 - 27.0 | | 24.0 - 34.0 | | 28.0 - 42.0 | |
| | | CFM | 618 - 953 | | 848 - 1200 | | 989 - 1483 | |
| | External static pressure* | Pa | 30-50 | | 30-50-70 | | | |
| | Operation control and thermostat | | Remote control and Built-in | | | | | |
| | Noise level (low-high) | dB (A) | 30-38 | | 34 - 42 | | 36-44 | |
| | Unit drain pipe | | mm | | 32 | | | |
| | Dimensions | W | mm | 1,100 | | 1,400 | | |
| D | | mm | 732 | | | | | |
| H | | mm | 250 | | | | | |
| Weight | | kg | 29 | | 38 | | | |
| Outdoor unit | Model name | | PU-M18VAK-DA | PU-M24VAK-DA | PU-M30VAK-DA | PU-M36YAK-DA | PU-M48YAK-DA | |
| | Power supply | | 1ph 220-240V 50Hz | | | 3ph 380-415V 50Hz | | |
| | External finish | | Munsell 3.0Y 7.8/1.1 | | | | | |
| | Refrigerant (R32) control | | Capillary Tube | | | | | |
| | Airflow | CMM (CFM) | 32 (1130) | 59 (2084) | 50 (1765) | 92 (3249) | | |
| | Noise level | dB (A) | 53 | 56 | 55 | 54 | 56 | |
| | Dimensions | W | mm | 718 | 840 | | 1050 | |
| | | D | mm | 255 | 330 | | 330 | |
| | | H | mm | 525 | 880 | | 981 | |
| | Weight | | kg | 35 | 51 | 63 | 82 | 86 |
| | Max. height difference | | m | 20 | | 30 | | |
| | Max. piping length | | m | 35 | | 50 | | |
| Pipe size (outer diameter) | | mm | Liquid: 6.35 , Gas: 12.7 | Liquid: 6.35 ,Gas: 15.88 | Liquid: 9.52 , Gas: 15.88 | | | |

| | | |
|-----------------|-------------------|----|
| Operating Range | Upper limit (CDB) | 46 |
| | Lower limit (CDB) | 21 |

- Rating conditions Cooling - Indoor: 27°C(80°F)DB, 19°C(66°F)WB, Outdoor: 35°C(95°F)DB
- Refrigerant piping length (one-way): 7.5m(25ft)
- Total input based on the indicated voltage (indoor/outdoor): 1ph 230V 50Hz, 3ph 400V 50Hz
- The sound pressure measurement is conducted in an anechoic chamber under the test conditions of Japanese industrial Standards.
- The actual sound level depends on the design and appropriate set up of duct work, distance from the unit and acoustic environment
- Measured with a 2.0m. Air outlet duct and 1.0m. Air inlet duct attached Measured point 1.5m. Below the unit.
- Rated External static pressure 30 Pa (PE-M18/24), 50Pa (PE-M30/36/48)

CONTROL TECHNOLOGIES

Mr.SLIM

Advanced MA Remote Controller – A Progressive Step in the Evolution of Air Conditioning Control



PAR-21MAA

Dot Liquid-crystal Display Adopted

The adoption of dot liquid-crystal display (LCD) technology and a large display screen for the control panel optimise visibility. Operation and control status are easily read at a glance.

Display Example [Operation Mode]

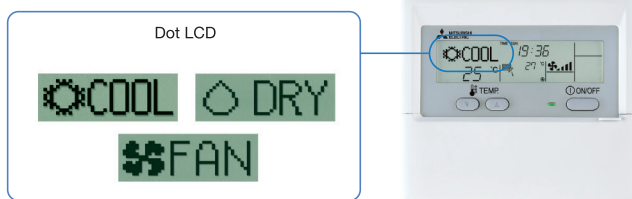

Easy-to-Read/Easy-to-Use

Multi-language

Multi-language Display

Control panel operation in eight different languages

Choose the desired language from among the following.

- | | | | |
|-----------|-----------|-----------|------------|
| [English] | [Spanish] | [Italian] | [German] |
| [French] | [Russian] | [Chinese] | [Japanese] |

Energy-efficient Control

Operation Control Functions

Temperature Range Restriction

Air conditioner operation restricted to within a specified operating range

Set the upper and lower limits for the temperature range during operation. Excessive cooling is prevented, leading to increased energy savings.

Cooling/Dry (Setting example of minimum temp. at 25°C)

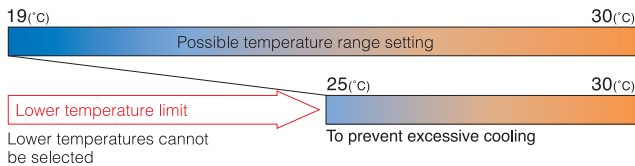

Recommended for **Office** **Restaurant**

Auto-off Timer

Automatically turns off air conditioner

Set the time for the air conditioner to turn off automatically. The timer can be set in the range from 30 minutes up to 4 hours in 30-minute intervals. The "Simple Timer"—starts/stops in units of 1 hour in a 72-hour period—is set at the time of shipment from the factory. It can be changed to the "Auto-off Timer" function using the remote controller.

Recommended for **Meeting room** **Changing room**

Operation Lock

Prevent operation settings from being changed

Units can be set so that the operation mode cannot be changed. When "Operation Lock" is activated, new temperature setting commands are not accepted, thereby ensuring that the unit runs in the specified (locked in) temperature range. This promotes energy savings and prevents erroneous/ mischievous operation. Only the administrator can change settings when using the Operation Lock mode.

Recommended for **Office** **School** **Public hall**
Hospital **Computer server facility**

Weekly Timer

Introduced in response to market demand

Control temperature on a weekly basis. Temperature settings and On/Off control can be managed over a period of one week using the Weekly Timer. Up to eight setting patterns per calendar day are possible.

Setting Example (restaurant in summer time)

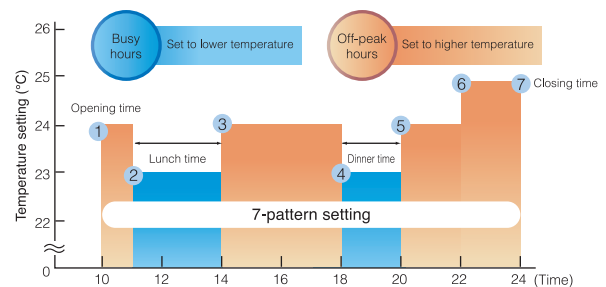

(Results of cooperative study with Japan Facility Solutions, Inc.)

Simple wireless remote controller with all the latest programming features



PAR-SL97A-E

- **FAN SPEED SELECT button**
Used to change fan speed.
- **VANE CONTROL button**
Used to change airflow direction.
- **MODE SELECTION button**
Used to select operating modes — Cool, Dry and Fan.
- **TIMER CONTROL buttons**
STOP (OFF timer): When this function is activated, the air conditioner will automatically stop at the preset time.
START (ON timer): When this function is activated, the air conditioner will automatically start at the preset time.
- **FAN SPEED INDICATOR**
Displays the fan speed (HIGH or LOW).
- **HOUR and MINUTE buttons**
Used to set the time and timer settings.
- **TIMER button/RESET button**

R32 REFRIGERANT

R32 REFRIGERANT PROPERTIES

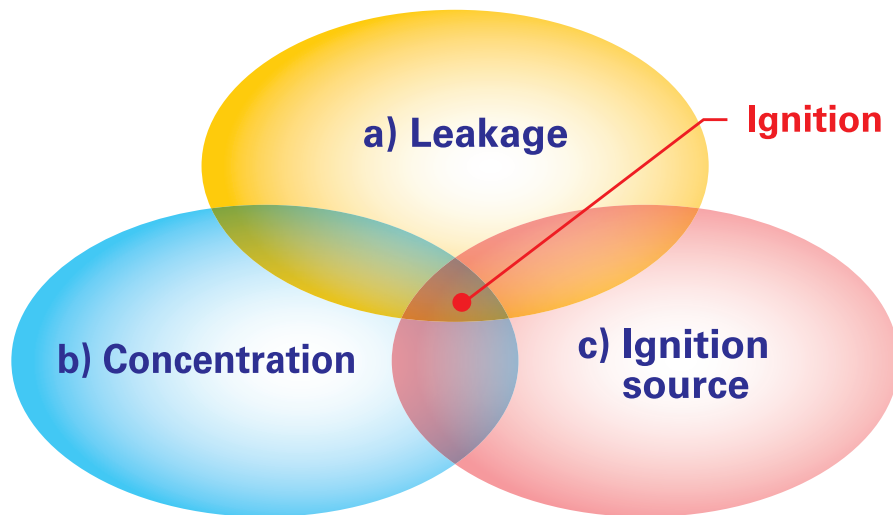

| | R32 | R410A | R22 |
|---------------------------------|--------------------------------|--|--------------------|
| Chemical formula | CH ₂ F ₂ | CH ₂ F ₂ /CHF ₂ CF ₃ | CHClF ₂ |
| Composition (blend ratio wt. %) | Single composition | R32/R125 (50/50 wt %) | Single composition |
| Ozone depletion potential (ODP) | 0 | 0 | 0.055 |
| Global warming potential (GWP)* | 675 | 2088 | 1810 |

*IPCC 4th assessment report.

R32 is classified as low flammability, the possibility of igniting can be further eliminated by ensuring the following three points.

a) Do not leak refrigerant.

- <Installation> ·Vacuum drying should be done. Air purging is prohibited.
- Follow "4. Installation Points of Refrigerant Piping Work".
- <Repair/Relocation/Removal> ·Pump down or recovering refrigerant should be done.

b) Prevent concentration.

- Ventilate during installation and servicing, such as open the door or window and use a fan.
- Follow "2. Installation Restrictions".

c) Keep ignition source away from the unit.

- Do not braze pipe and unit which contain refrigerant. Before brazing, refrigerant should be recovered.
- Do not install unit while the electricity is turned on. Turn off electricity at the fuse box and check the wiring using a tester.
- Do not smoke when working or during transportation of the product.

NOTE & OUTDOOR UNIT

Notes for All Specifications

Rating conditions

Cooling - Indoor: 27°C (80°F) DB, 19°C (66°F) WB
Outdoor: 35°C (95°F) DB

Refrigerant piping length (one-way): 7.5m (25ft)

Total input based on the indicated voltage (indoor/outdoor)

| 50Hz | Indoor Single-phase, 220-240V | Outdoor | |
|------|----------------------------------|------------------------|-----------------------|
| | | PU-M18/24/30 | PU-M36/48YAK |
| | | Single-phase, 220-240V | Three-phase, 380-415V |

Guaranteed Operating Range

| Cooling | PU-M18/24/30VAK | | PU-M36/48YAK |
|------------------|------------------|--|--------------|
| | Upper limit (DB) | | |
| Lower limit (DB) | | | 21°C |

Sound Pressure Level

- Sound pressure measurements were conducted in an anechoic chamber.
- The actual noise level depends on the distance from the unit and the acoustic environment.

Refrigerant Piping

| Capacity | Between indoor and outdoor units | | Pipe size (mm, outer dia.) | Thickness (mm) |
|-------------------------------------|----------------------------------|------------------------|----------------------------|----------------|
| | Max. height difference (m) | Max. piping length (m) | | |
| PU-M18VAK | 20 | 35 | Liquid: ø6.35 | t 0.8 |
| | | | Gas: ø12.7 | t 0.8 |
| PU-M24VAK | 20 | 35 | Liquid: ø6.35 | t 0.8 |
| | | | Gas: ø15.88 | t 1.0 |
| PU-M30VAK PU-M36YAK PU-M48YAK | 30 | 50 | Liquid: ø9.52 | t 0.8 |
| | | | Gas: ø15.88 | t 1.0 |

Refrigerant Requirements (R32: g)

| Piping length | Factory charged | Additional charge | | | | | | | | | | Calculation |
|---------------|-----------------|-------------------|-----|-----|-----|-----|-----|-----|-----|-----|-----|--|
| | | 7.5m | 10m | 15m | 20m | 25m | 30m | 35m | 40m | 45m | 50m | |
| PU-M18VAK | 1,010 | 0 | 25 | 75 | 125 | 175 | 225 | 275 | — | — | — | $Xg = 10g/m \times (\text{length} - 7.5)m$ |
| PU-M24VAK | 1,240 | | 25 | 75 | 125 | 175 | 225 | 275 | — | — | — | $Xg = 10g/m \times (\text{length} - 7.5)m$ |
| PU-M30VAK | 1,520 | | 50 | 150 | 250 | 350 | 450 | 550 | 650 | 750 | 850 | $Xg = 20g/m \times (\text{length} - 7.5)m$ |
| PU-M36YAK | 2,400 | | 0 | 100 | 200 | 300 | 400 | 500 | 600 | 700 | 800 | $Xg = 20g/m \times (\text{length} - 10)m$ |
| PU-M48YAK | 2,200 | | | | | | | | | | | |

• When installing a single outdoor unit

■ PU-M18VAK

■ PU-M24VAK
■ PU-M30VAK

■ PU-M36YAK
■ PU-M48YAK

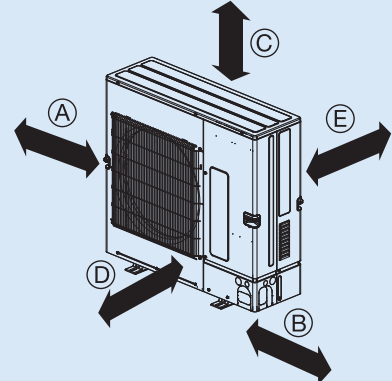
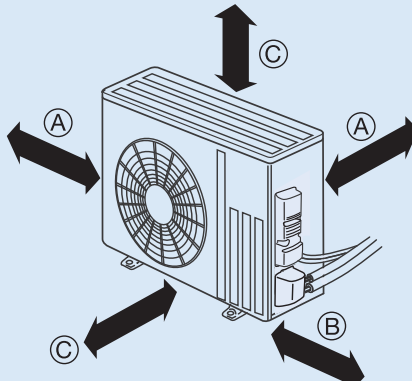
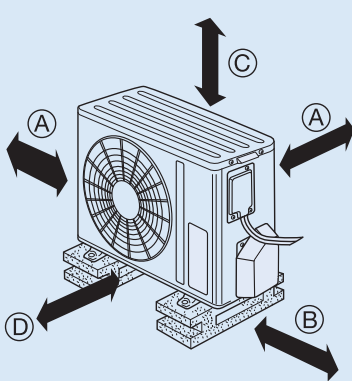

| | PU-M18VAK | PU-M24/30VAK |
|---|---------------|---------------|
| A | 100mm or more | |
| B | 350mm or more | |
| C | 100mm or more | 500mm or more |
| D | 200mm or more | — |

| | PU-M36Y/48YAK |
|---|-----------------|
| A | 250mm or more |
| B | 250mm or more |
| C | 1,500mm or more |
| D | Free |
| E | 500mm or more |

[Notice] If there is any obstruction around the unit, check the condition details in the Data Book.

OPTIONAL PARTS

Main Optional Parts

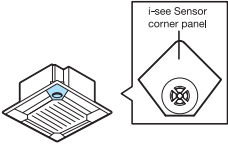
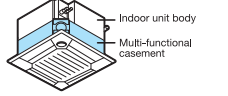
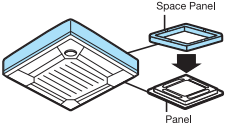
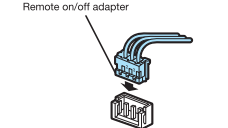
| Part name | Description |
|---|--|
| i-see Sensor Corner Panel Corner panel holding the i-see Sensor. |  |
| Multi-functional Casement Casement for attaching the high-efficiency filter element (optional). |  |
| Space Panel Decorative cover for installation when the ceiling height is low. |  |
| Remote On/Off Adapter Connector for receiving signals from the local system to control the on/off function. |  |

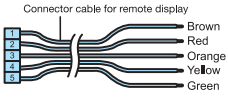
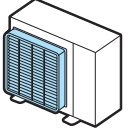
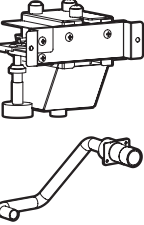
| Part name | Description |
|--|--|
| Connector Cable for Remote Display Connector used to display the operation status and control the on/off function from a distance. |  |
| Air Discharge Guide Changes the direction of air being exhausted from the outdoor unit. |  |
| Drain Pump for PE Series Raises drain generated during units operation to secure the appropriate angle of the drain pipe. |  |

Main Optional Parts

| Part name | Model name | Applicable models |
|--|---------------------------|-------------------|
| Drain pump | PAC-DRP06SL-E | PE-M.JAK |
| Insulation for high humidity condition | PAC-SH62HK-E | PL-M.BAK |
| M-NET and Terminal interface | MAC-334IF-E | All indoor units |
| Wireless remote controller | PAR-SL97A-E | PE-M.JAK |
| Wireless remote controller signal receiver | PAR-SA9CA-E | PE-M.JAK |
| | PAR-SA9FA-E | PL-M.BAK |
| High-efficiency filter element | PAC-SH59KF-E | PL-M.BAK |
| Filter box | PAC-KE93TB-E | PE-M18/24JAK |
| | PAC-KE94TB-E | PE-M30/36/48JAK |
| i-see sensor corner panel | PAC-SA1ME-E | PL-M.BAK |
| Multi-function casement | PAC-SH53TM-E | PL-M.BAK |
| Remote On/Off adapter | PAC-SE55RA-E | All indoor units |
| Remote sensor | PAC-SE41TS-E | All indoor units |
| Space panel | PAC-SH48AS-E | PL-M.BAK |
| Connector cable for remote display | PAC-SA88HA-E | All indoor units |
| Wired remote controller | PAR-21MAA | PE-M.JAK |
| Multiple remote controller adapter | PAC-725AD | All indoor units |
| Air outlet guide | PAC-SH96SG-E | PU-M36Y/48Y |
| Drain socket | PAC-SG61DS-E | PU-M36Y/48Y |
| Centralized drain pan | PAC-SH97DP-E | PU-M36Y/48Y |
| Joint pipe | PAC-SG73RJ-E PAC-SG75RJ-E | PU-M36Y/48Y |
| Filter dryer for liquid pipe | PAC-SG82DR-E | PU-M36Y/48Y |

 **NOTICE**

- Do not install indoor units in areas (e.g. mobile phone base stations) where the emission of VOCs such as phthalate compounds and formaldehyde is known to be high as this may result in a chemical reaction.
- Our air-conditioning equipments contain a fluorinated greenhouse gas, R32 (GWP: 675). *This GWP value is based on Regulation (EU) No.517/2014 from IPCC 4th edition. In case of Regulation (EU) No.626/2011 from IPCC 3rd edition, R32 (GWP: 550)
- When installing or relocating or servicing our air-conditioning equipment, use only the specified refrigerant R32 to charge the refrigerant lines. Do not mix it with any other refrigerant and do not allow air to remain in the lines. If air is mixed with the refrigerant, then it can be the cause of abnormal high pressure in the refrigerant lines, and may result in an explosion and other hazards.
The use of any refrigerant other than that specified for the system will cause mechanical failure, system malfunction or unit breakdown. In the worst case, this could lead to a serious impediment to securing product safety.

RELIABILITY FACTS

Always Quality First

Cutting-edge technologies and uncompromising commitment to quality and reliability have made Mitsubishi Electric one of the world's most trusted brands in air-conditioning and refrigeration equipment and service.

DEVELOPMENT

Combustion Test

Products are subjected to a wide range of tests including combustion testing and salt damage testing - all to confirm safe operation under a variety of conditions. Combustion testing is done by assuming accidental firing and replicating abnormal conditions that cause breakage of pressure components.

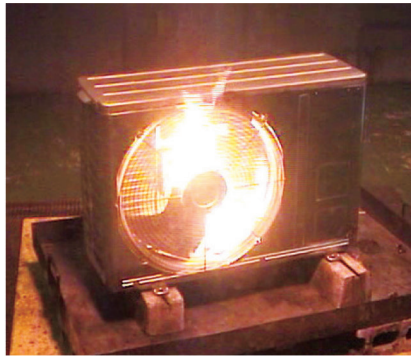

Combustion testing



Explosion-proof chamber

Shock Resistance

On the assumption of many different kinds of logistics environments in the world, we perform drop/strength tests, transport vibration tests, and many other product checks to assure that the quality and performance are maintained when the product reaches the user's home.



Drop/strength testing



Transport vibration testing

Waterproof Test

Since the outdoor unit is subject to rain and wind, potential problems are checked by tests such as showering the unit for a certain amount of time.



Operation Noise Test

Operation noise tests are performed in an anechoic chamber with an extremely low 10dB of background noise. This is just one of the ways Mitsubishi Electric ensures its customers enjoy extremely calm environments with a quiet operation noise (sound pressure level).



Anechoic chamber

DESIGN

Designed to create and maintain a comfortable environment

To improve the quality of our products, the engineers strive to achieve its philosophy of combining ecology and comfort to an even higher level. Therefore, we are working to further improve quality at all stages from development to production.



PRODUCTION

Each and every unit is checked and double-checked by experienced professionals

Every air conditioner goes through rigorous electrical inspection on the manufacturing line. In final testing, our experienced inspectors listen for even the faintest operation noise to detect any fault.





MITSUBISHI ELECTRIC INDIA PVT. LTD.

HEAD OFFICE: 3rd Floor, Tower A, Global Gateway, MG Road, Gurugram – 122002 (Haryana)

Tel. No.: (Main): 0124-6739300/301 **Website:** www.MitsubishiElectric.in **Email:** customersupport@asia.meap.com

BRANCH/SALES OFFICES: Ahmedabad: 079-67777888; Bhubaneswar: 09073949597; Bengaluru: 080-40201600; Coimbatore: 0422-4385606; Chandigarh: 0172-4601645; Chennai: 044-49232222; Delhi: 011-66057900; Ghaziabad: 011-66057900; Hyderabad: 040-43438888; Indore: 0731-4098991; Jaipur: 0141-4011109; Kolkata: 033-40858800/16-88; Kochi: 0484-4862093; Lucknow: 0522-4002607; Ludhiana: 0161-4061654; Mumbai: 022-66116200; Nagpur: 09921442323; Pune: 09922441773; Rajkot: 09586605009; Surat: 0261-4003111; Vadodara: 0265-2314699; Vijaywada: 08498894567.

SATELLITE OFFICES: Agra: 09536900140; Amritsar: 09780021037; Aurangabad: 09552572820; Bhopal: 08448398010; Dehradun: 08800878763; Goa: 09167113443; Hubli: 08448398010; Kanpur: 07755007767; Patna: 09073949596; Raipur: 08448397997; Ranchi: 0973949598; Tirupati: 09319591931; Trichy: 09205599022; Varanasi: 09336311110; Vizag: 09205987308

Customer Care Toll Free No.: 1800 102 2626

TECHNICAL CENTRES: Ahmedabad: 079-67777874; Bengaluru: 080-40201600; Chennai: 044-49232222; Delhi: 011-66057900; Mumbai: 022-66116200



*For E-waste Collection & Disposal process: Customer can get complete details of company process on collection, disposal of e-waste product (i.e. 'Mitsubishi Electric' make Air Conditioner) and incentive / exchange scheme for returning of e-waste on **Company website (www.MitsubishiElectric.in)** or by calling on **Toll free number 1800 102 2626**.

Specifications subject to change without notice.